

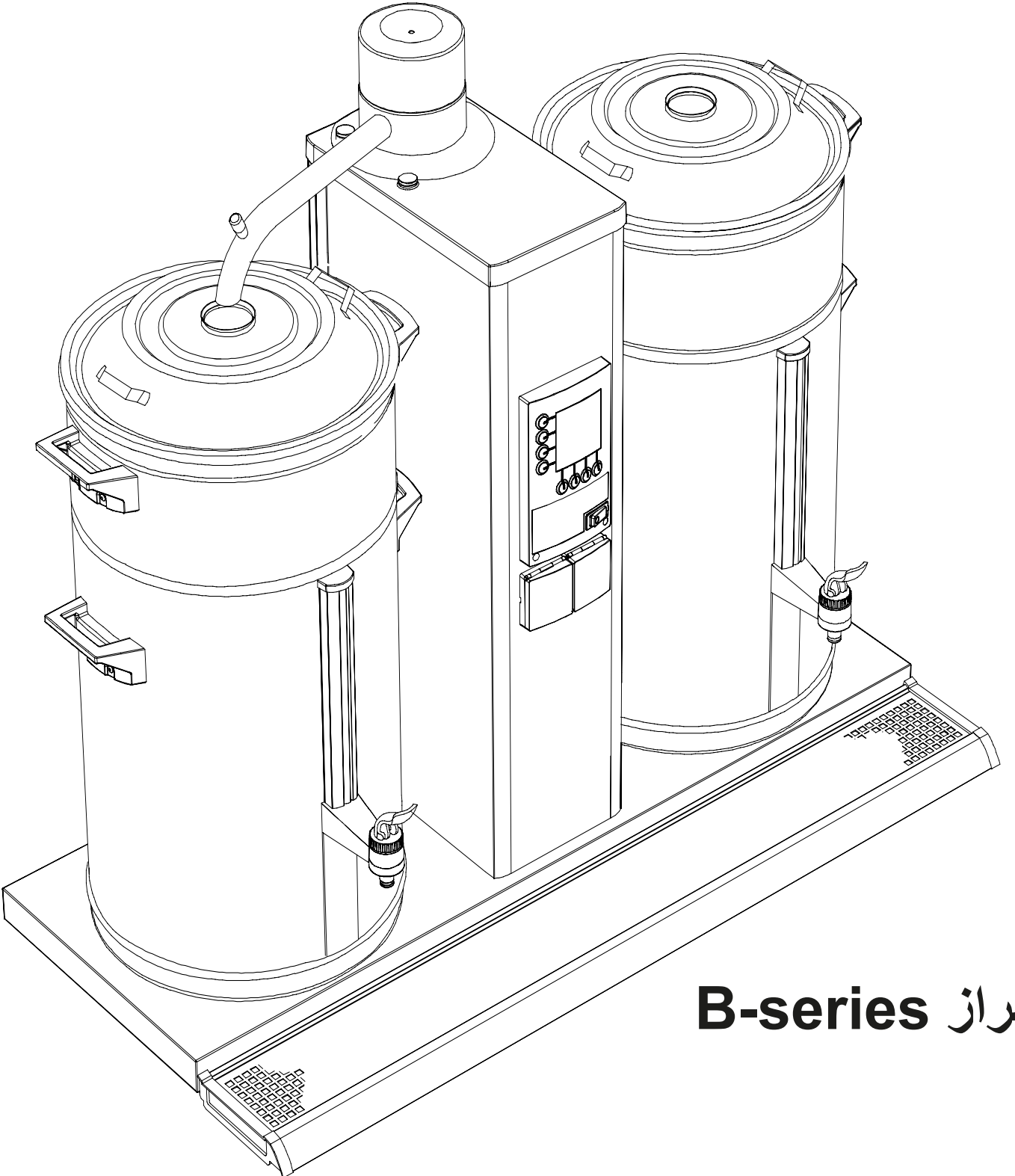













# /// BRAVILO<sup>®</sup> /// BONAMAT

## تعليمات التشغيل الصور

ماكينة تحضير القهوة مستدير مزودة بمرشح



طراز B-series

	English	العربية	
.1	 Use	الاستخدام	
	 Dripping	التقطير	
.2	 Cleaning, frequently	التنظيف، بشكل متكرر	
	 Wait	انتظر	
	 Acoustic signal	الإشارة الصوتية	
.3	 Descaling	إزالة التكلس	
	 Read Operating Instructions	اقرأ تعليمات التشغيل	
.4	Initial use	الاستخدام الأولي	
.5	Programming (operator)	البرمجة (المشغل)	
	 Selection keys	مفاتيح الاختيار	
	 Confirm	تأكيد	
	 Cancel	إلغاء	
	 Water hardness	تعسر الماء	
	 Read Operating Instructions	اقرأ تعليمات التشغيل	
.6	Programming (principal)	البرمجة (الأساسية)	
	 Selection keys	مفاتيح الاختيار	
	 Confirm	تأكيد	
	 Cancel	إلغاء	
	 Off	إيقاف تشغيل	
	 Min.	دقيقة	
	 Standard	قياسي	
	 Max.	الحد الأقصى	
	 Water hardness	تعسر الماء	
	 Read Operating Instructions	اقرأ تعليمات التشغيل	
		Hold 10 sec.	انتظر 10 ثوانٍ
		Select desired time setting (1-14)	حدد إعداد الوقت المطلوب (1-14)
	.7	Error codes	رموز الخطأ

## 1. الاستخدام (B)

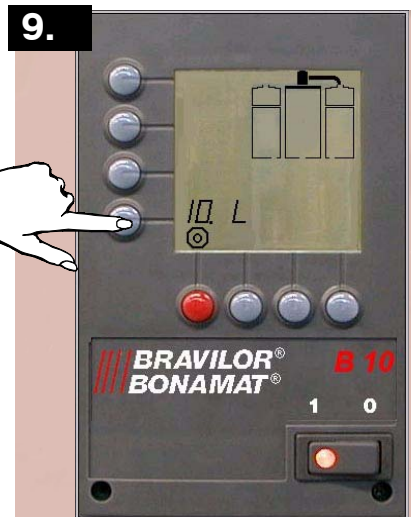
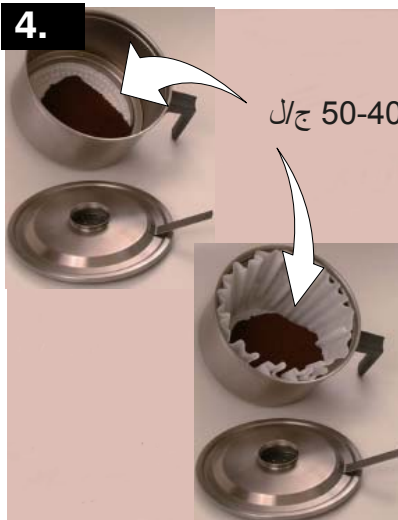
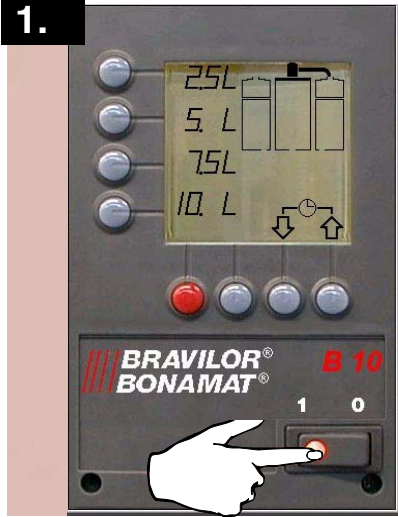

10.



11.



12.



13.



14.



15.





## 2. التنظيف، بشكل متكرر (B)

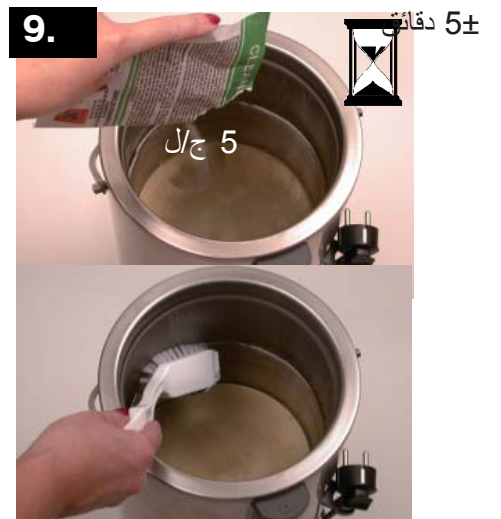
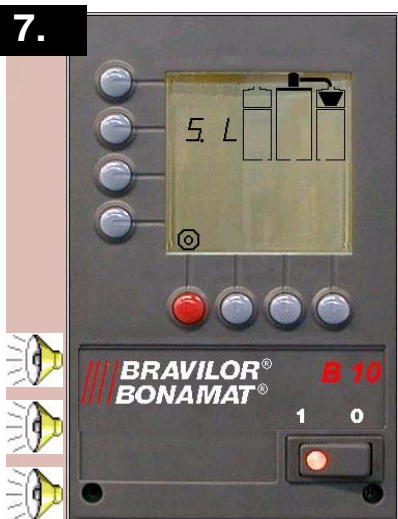
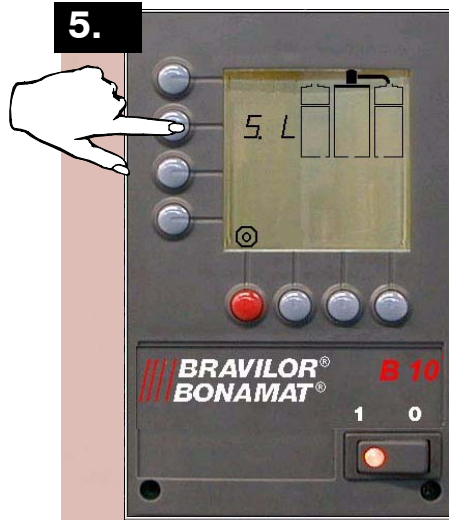
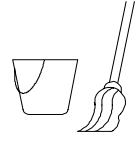

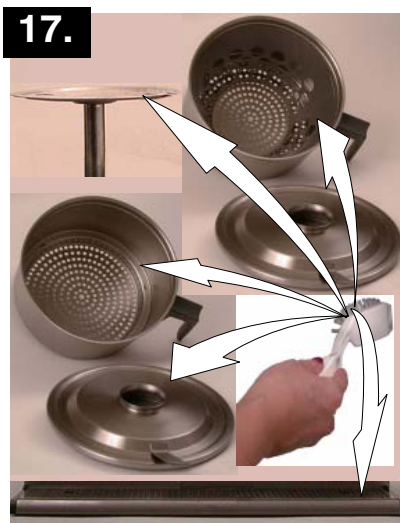
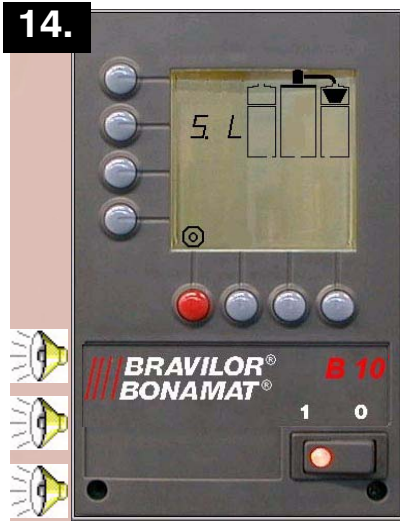
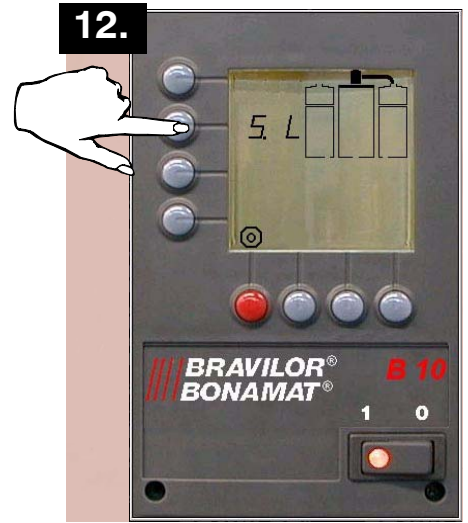





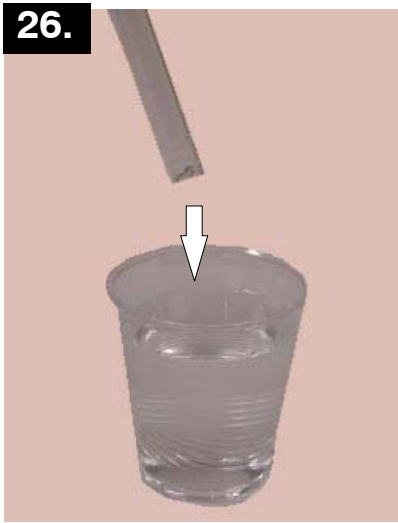



## 3. إزالة تكلس ماكينة تحضير القهوة (المشغل) (B)

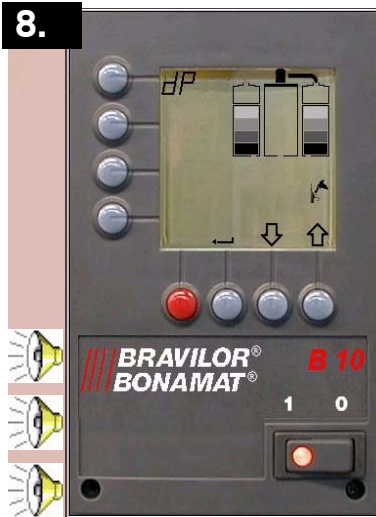
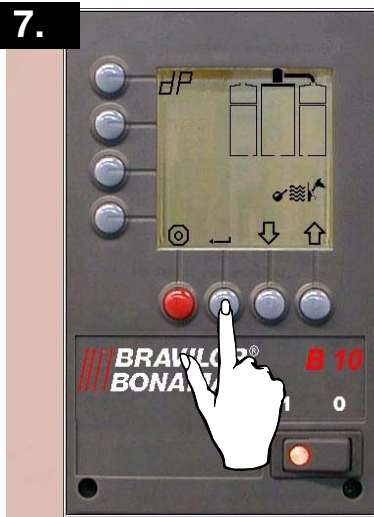
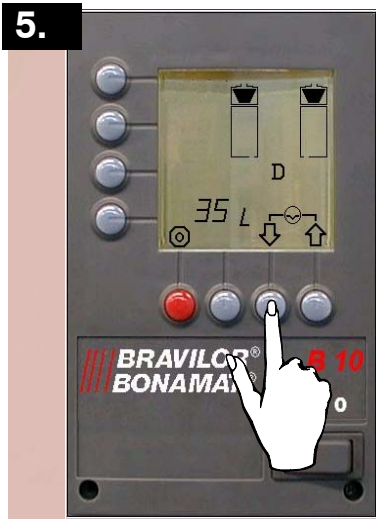
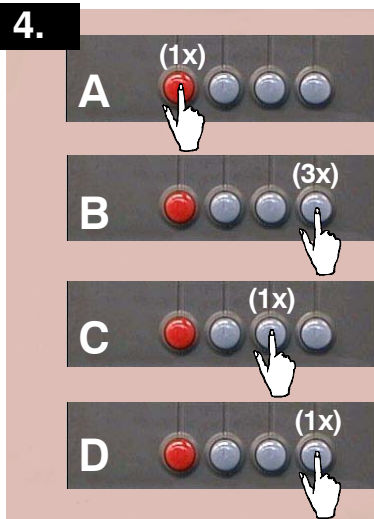
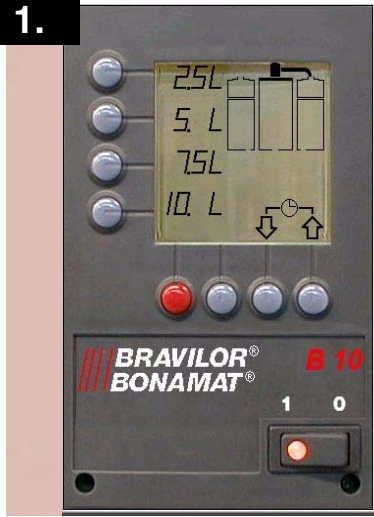

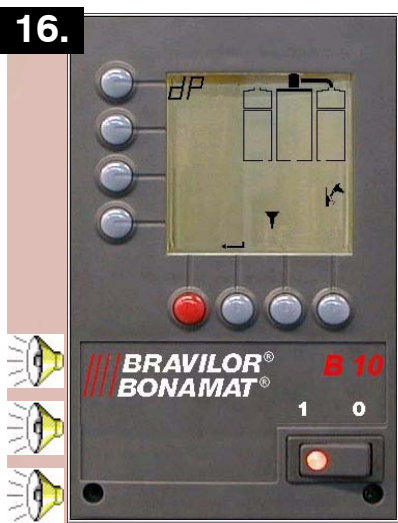
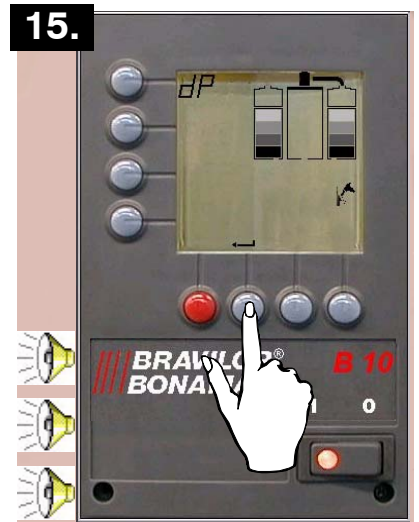
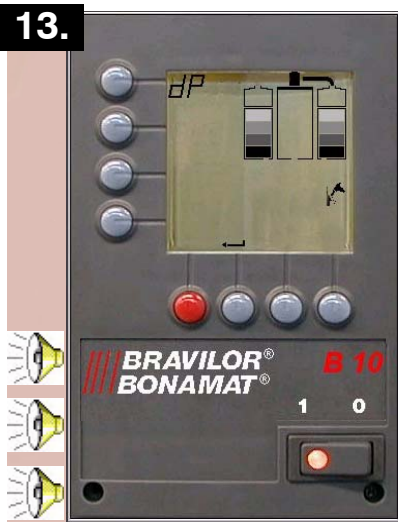
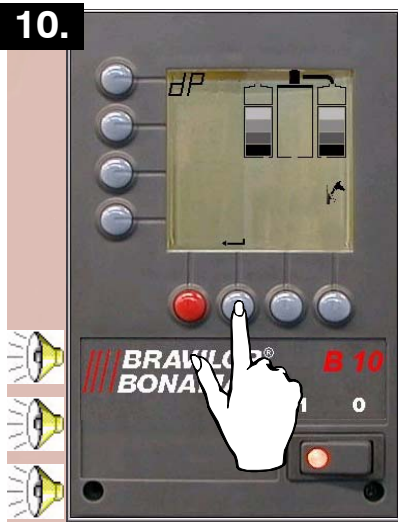

(°40 ±) 0.75 / 100



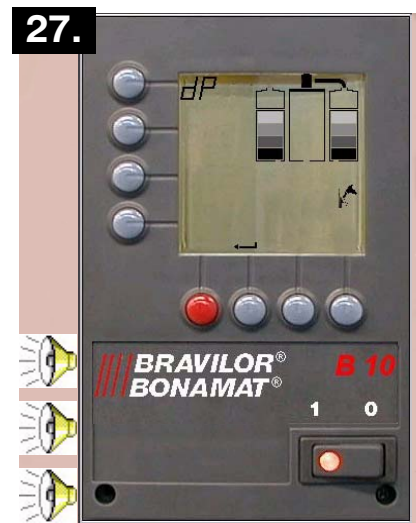
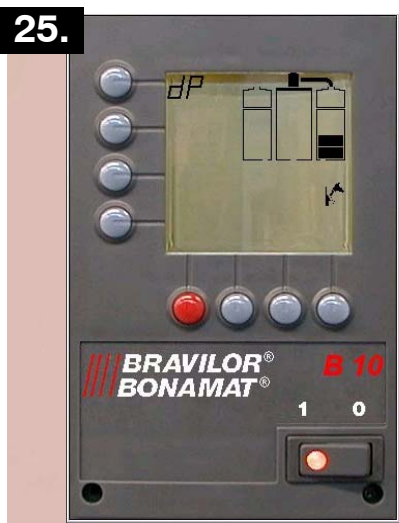
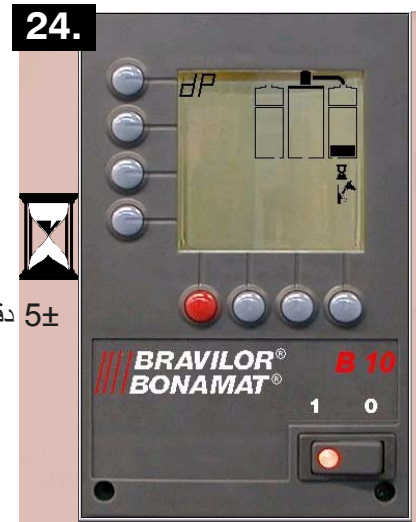
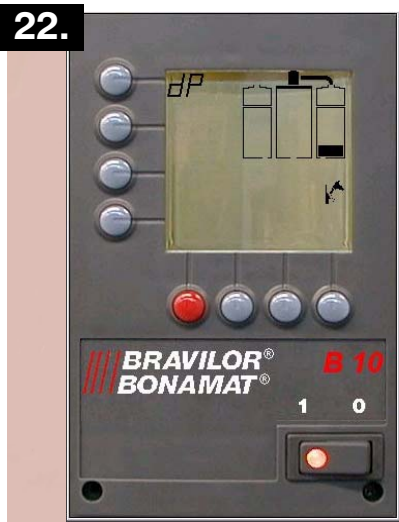
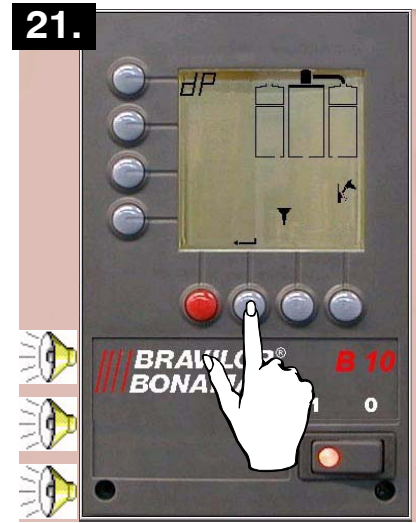

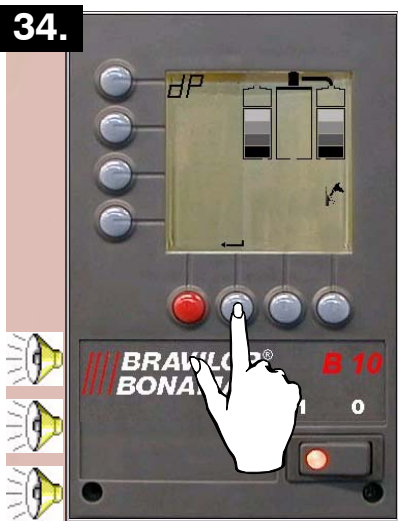
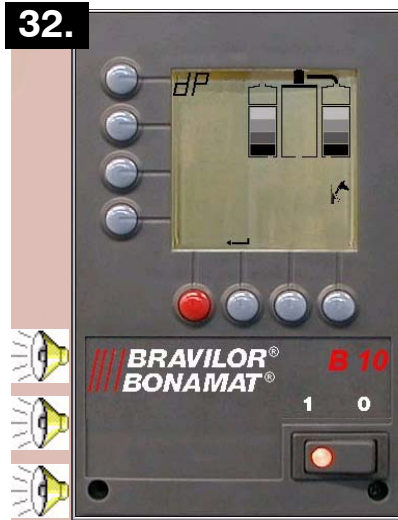
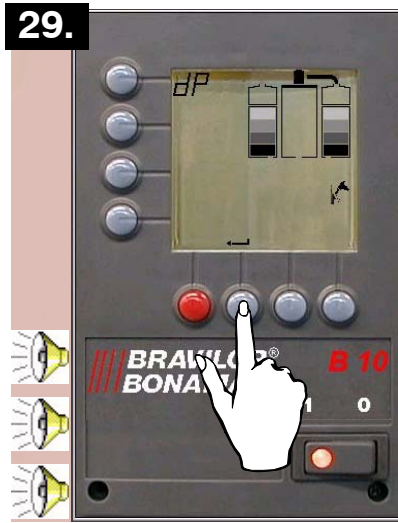



37.

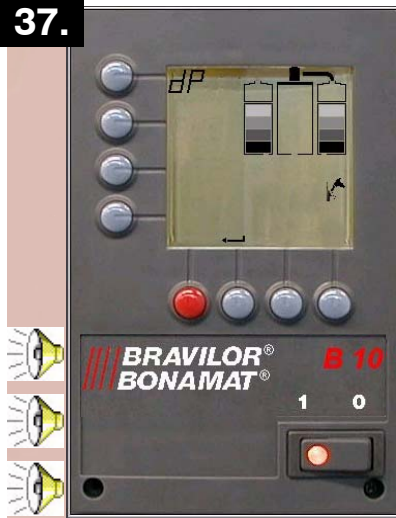

38.



39.

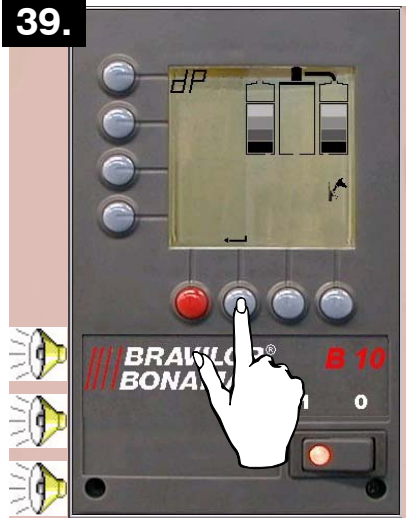

40.



41.

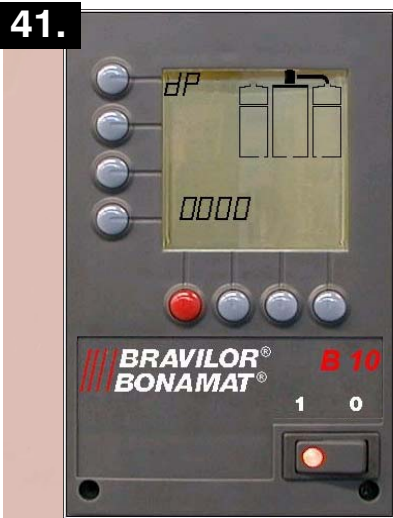

42.



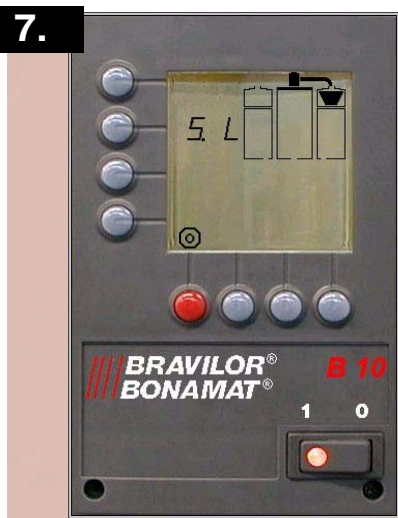
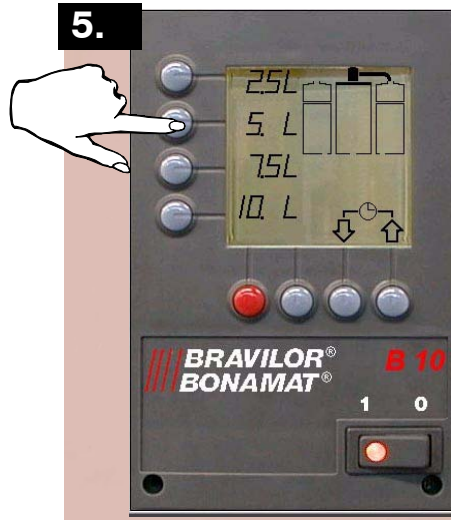
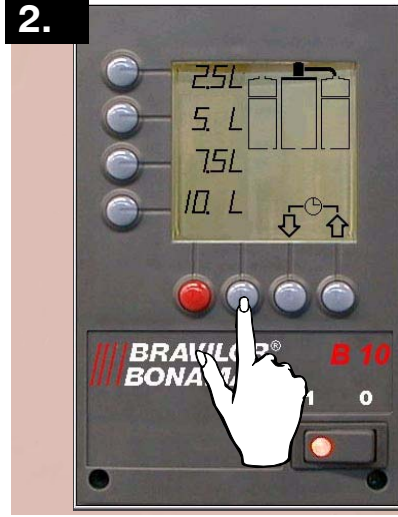

## 4. الاستخدام الأولي (B)

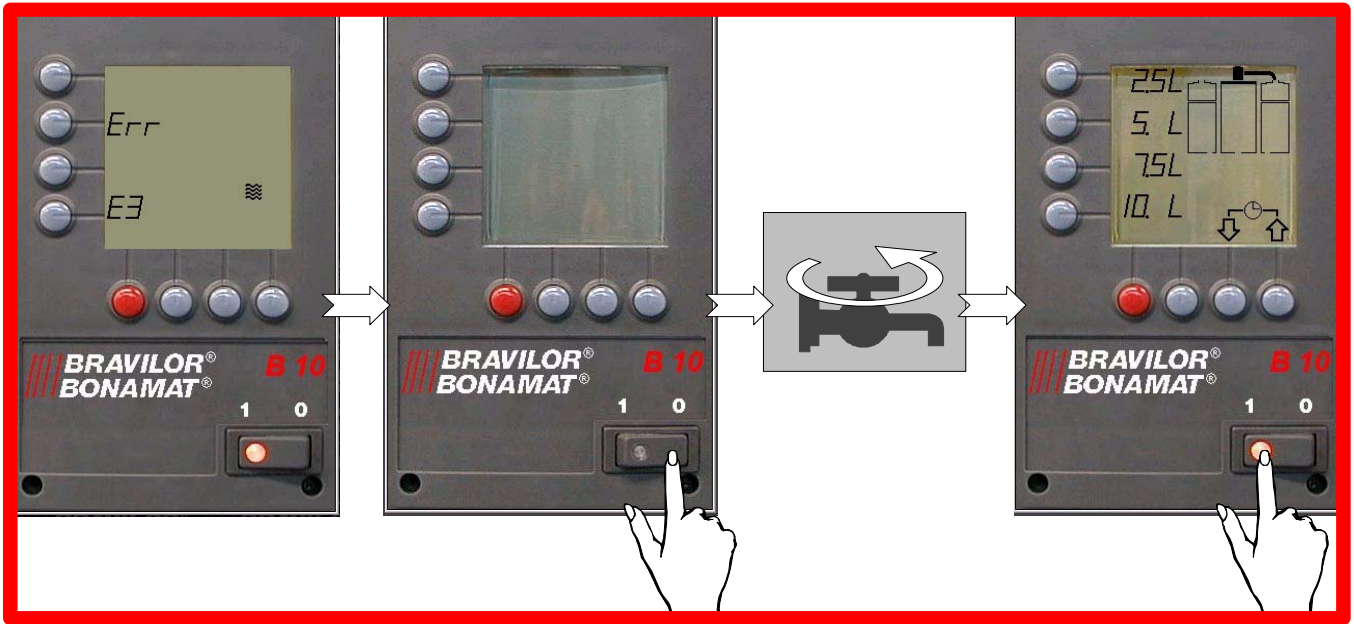



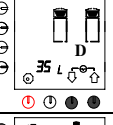
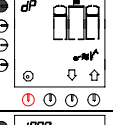
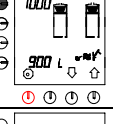

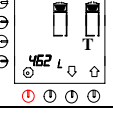









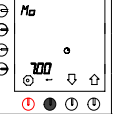
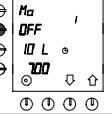
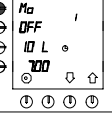
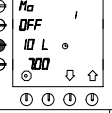
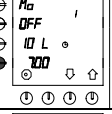
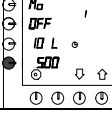





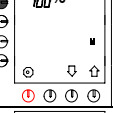

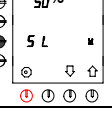







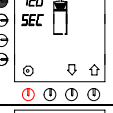



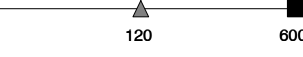

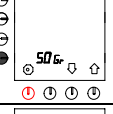







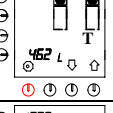

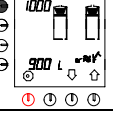

## 5. البرمجة (B) (المشغل)

 >5 ثوانٍ			↓ + ↑	= 0	
↓ ↑				§ 3.	
↓ ↑			↓ / ↑	← / ⊙	 → 
↓ ↑					
●					

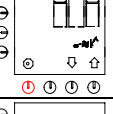

## 6. البرمجة (B) (المستخدم الأساسي)

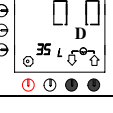
				<table border="1"> <tr> <td>B5</td> <td>4.8</td> <td>5.3</td> <td>5.8</td> </tr> <tr> <td>B10</td> <td>10.6</td> <td>9.6</td> <td>11.6</td> </tr> <tr> <td>B20</td> <td>19.2</td> <td>21.2</td> <td>23.2</td> </tr> <tr> <td>B40</td> <td>38.4</td> <td>42.4</td> <td>46.4</td> </tr> </table>	B5	4.8	5.3	5.8	B10	10.6	9.6	11.6	B20	19.2	21.2	23.2	B40	38.4	42.4	46.4																																																																
B5	4.8	5.3	5.8																																																																																	
B10	10.6	9.6	11.6																																																																																	
B20	19.2	21.2	23.2																																																																																	
B40	38.4	42.4	46.4																																																																																	
				<table border="1"> <tr> <td>B5</td> <td>1</td> <td>1 - 3</td> <td>4 - 5</td> <td>5</td> </tr> <tr> <td>B10</td> <td>2</td> <td>2.5- 5-</td> <td>7.5-10</td> <td>10</td> </tr> <tr> <td>B20</td> <td>4</td> <td>5 -10-15</td> <td>-20</td> <td>20</td> </tr> <tr> <td>B40</td> <td>8</td> <td>10 -20-30</td> <td>-40</td> <td>40</td> </tr> </table> <p style="text-align: center;">50      125      200</p> <table border="1"> <tr> <td>B5</td> <td>8</td> <td>8- 24-</td> <td>32- 40</td> <td>40</td> </tr> <tr> <td>B10</td> <td>20</td> <td>20- 40-</td> <td>60- 80</td> <td>80</td> </tr> <tr> <td>B20</td> <td>40</td> <td>40- 80-</td> <td>120-160</td> <td>160</td> </tr> <tr> <td>B40</td> <td>80</td> <td>80-160-</td> <td>240-320</td> <td>320</td> </tr> </table> <p style="text-align: center;">50      250      3000</p> <table border="1"> <tr> <td>B5</td> <td>4</td> <td>4-12-</td> <td>16- 20</td> <td>20</td> </tr> <tr> <td>B10</td> <td>10</td> <td>10-20-</td> <td>30- 40</td> <td>40</td> </tr> <tr> <td>B20</td> <td>20</td> <td>20-40-</td> <td>60- 80</td> <td>80</td> </tr> <tr> <td>B40</td> <td>40</td> <td>40-80-</td> <td>120-160</td> <td>160</td> </tr> </table> <table border="1"> <tr> <td>B5</td> <td>0.30</td> <td>0.30-0.65-</td> <td>0.95- 1.30</td> <td>1.30</td> </tr> <tr> <td>B10</td> <td>0.65</td> <td>0.65-1.30-</td> <td>1.95- 2.60</td> <td>2.60</td> </tr> <tr> <td>B20</td> <td>1.30</td> <td>1.30-2.60-</td> <td>3.95- 5.25</td> <td>5.25</td> </tr> <tr> <td>B40</td> <td>2.60</td> <td>2.60-5.25-</td> <td>7.90-10.55</td> <td>10.55</td> </tr> </table>	B5	1	1 - 3	4 - 5	5	B10	2	2.5- 5-	7.5-10	10	B20	4	5 -10-15	-20	20	B40	8	10 -20-30	-40	40	B5	8	8- 24-	32- 40	40	B10	20	20- 40-	60- 80	80	B20	40	40- 80-	120-160	160	B40	80	80-160-	240-320	320	B5	4	4-12-	16- 20	20	B10	10	10-20-	30- 40	40	B20	20	20-40-	60- 80	80	B40	40	40-80-	120-160	160	B5	0.30	0.30-0.65-	0.95- 1.30	1.30	B10	0.65	0.65-1.30-	1.95- 2.60	2.60	B20	1.30	1.30-2.60-	3.95- 5.25	5.25	B40	2.60	2.60-5.25-	7.90-10.55	10.55
B5	1	1 - 3	4 - 5	5																																																																																
B10	2	2.5- 5-	7.5-10	10																																																																																
B20	4	5 -10-15	-20	20																																																																																
B40	8	10 -20-30	-40	40																																																																																
B5	8	8- 24-	32- 40	40																																																																																
B10	20	20- 40-	60- 80	80																																																																																
B20	40	40- 80-	120-160	160																																																																																
B40	80	80-160-	240-320	320																																																																																
B5	4	4-12-	16- 20	20																																																																																
B10	10	10-20-	30- 40	40																																																																																
B20	20	20-40-	60- 80	80																																																																																
B40	40	40-80-	120-160	160																																																																																
B5	0.30	0.30-0.65-	0.95- 1.30	1.30																																																																																
B10	0.65	0.65-1.30-	1.95- 2.60	2.60																																																																																
B20	1.30	1.30-2.60-	3.95- 5.25	5.25																																																																																
B40	2.60	2.60-5.25-	7.90-10.55	10.55																																																																																
				<p style="text-align: center;">88      97</p> <p style="text-align: center;">190      206</p>																																																																																
				<p>▲ EnG</p> <p>■ dEu, FrA, ESP, nEd</p> <p>▲ - - - - ■</p> <p>off      on</p>																																																																																

 		حدد إعداد الوقت المطلوب ↓ / ↑ (14-1)						 / 	 - - - -  off on
	 					 / 	 / 		
	 					 / 	 / 		
	 					 / 	 / 		
	 								
	 					 / 	 / 	 → 	
	 							§ 3. (المشغل)	
	 					 + 		= 0	

## 7. رموز الخطأ (B)

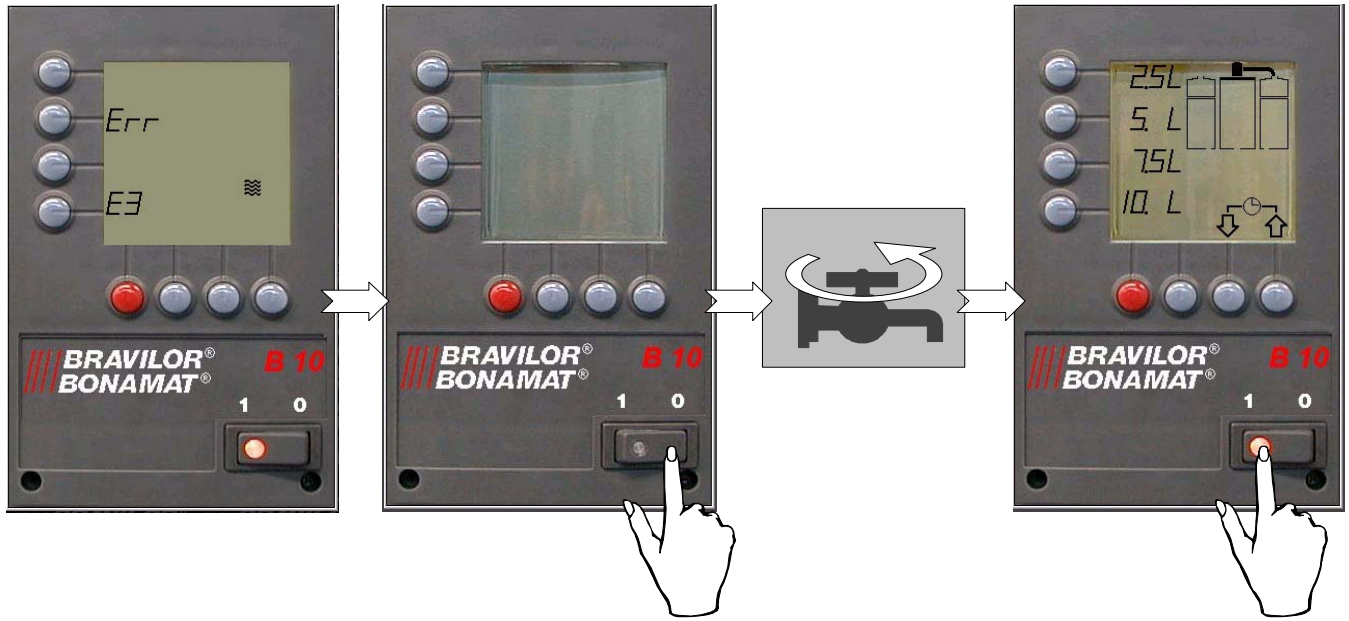



**BRAVILOR®**  
**BONAMAT**

ماكينات تحضير القهوة  
COFFEE BREWING MACHINES  
MACHINES A CAFE  
KAFFEEBRUEHMASCHINEN  
KOFFIEZETAPPARATEN

© 10 - 2015

700.403.771 A